

The software of this player may be updated in the future. For information about any available updates and the latest Operating Instructions, please visit the following website:  
<http://www.sony.com/bluraysupport/>



<http://www.sony.net/>

Printed on 70% or more recycled paper using VOC (Volatile Organic Compound)-free vegetable oil based ink.

4-285-922-12(1)



Printed in Malaysia

© 2011 Sony Corporation



## Operating Instructions

Blu-ray Disc™ / DVD Player

BDP-S480/S580/BX58

# WARNING

To reduce the risk of fire or electric shock, do not expose this apparatus to rain or moisture.

To avoid electrical shock, do not open the cabinet. Refer servicing to qualified personnel only.

The AC power cord must be changed only at a qualified service shop.

Batteries or batteries installed apparatus shall not be exposed to excessive heat such as sunshine, fire or the like.

## CAUTION

The use of optical instruments with this product will increase eye hazard. As the laser beam used in this Blu-ray Disc/DVD player is harmful to eyes, do not attempt to disassemble the cabinet.

Refer servicing to qualified personnel only.

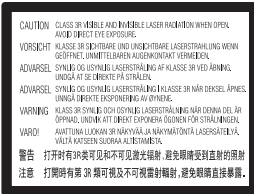

This label is located on the laser protective housing inside the enclosure.



This symbol is intended to alert the user to the presence of uninsulated "dangerous voltage" within the product's enclosure that may be of sufficient magnitude to constitute a risk of electric shock to persons.



This symbol is intended to alert the user to the presence of important operating and maintenance (servicing) instructions in the literature accompanying the appliance.

## Precautions

- To prevent fire or shock hazard, do not place objects filled with liquids, such as vases, on the apparatus.
- Install this unit so that the AC power cord can be unplugged from the wall socket immediately in the event of trouble.

Operation is subject to the following two conditions;  
(1) this device may not cause interference, and  
(2) this device must accept any interference received, including interference that may cause undesired operation of the device.

## FCC WARNING

You are cautioned that any changes or modifications not expressly approved in this manual could void your authority to operate this equipment.

This transmitter must not be co-located or operating in conjunction with any other antenna or transmitter.

The shielded Interface cable (LAN cable) must be used with the equipment in order to comply with the limits for a digital device pursuant to Subpart B of Part 15 of FCC Rules.



This equipment has been tested and found to comply with the limits for a Class B digital device, pursuant to Part 15 of the FCC Rules. These limits are designed to provide reasonable protection against harmful interference in a residential installation. This equipment generates, uses, and can radiate radio frequency energy and, if not installed and used in accordance with the instructions, may cause harmful interference to radio communications. However, there is no guarantee that interference will not occur in a particular installation. If this equipment does cause harmful interference to radio or television reception, which can be determined by turning the equipment off and on, the user is encouraged to try to correct the interference by one or more of the following measures:

- Reorient or relocate the receiving antenna.
- Increase the separation between the equipment and receiver.
- Connect the equipment into an outlet on a circuit different from that to which the receiver is connected.
- Consult the dealer or an experienced radio/TV technician for help.

## FCC Radiation Exposure Statement:

This equipment complies with FCC radiation exposure limits set forth for an uncontrolled environment and meets the FCC radio frequency (RF) Exposure Guidelines in Supplement C to OET65. This equipment should be installed and operated keeping the radiator at least 20cm or more away from person's body (excluding extremities: hands, wrists, feet and ankles).

## IC Radiation Exposure Statement:

This equipment complies with IC radiation exposure limits set forth for an uncontrolled environment and meets RSS-102 of the IC radio frequency (RF) Exposure rules. This equipment should be installed and operated keeping the radiator at least 20cm or more away from person's body (excluding extremities: hands, wrists, feet and ankles).

For BDP-S580/BX58 only

Contains FCC ID : EW4DWMW042

Contains IC : 4250A-DWMW042

This class B digital apparatus complies with Canadian ICES-003.

## Important Safety Instructions

- 1) Read these instructions.
  - 2) Keep these instructions.
  - 3) Heed all warnings.
  - 4) Follow all instructions.
  - 5) Do not use this apparatus near water.
  - 6) Clean only with dry cloth.
  - 7) Do not block any ventilation openings. Install in accordance with the manufacturer's instructions.
  - 8) Do not install near any heat sources such as radiators, heat registers, stoves, or other apparatus (including amplifiers) that produce heat.
  - 9) Do not defeat the safety purpose of the polarized or grounding-type plug. A polarized plug has two blades with one wider than the other. A grounding type plug has two blades and a third grounding prong. The wide blade or the third prong are provided for your safety. If the provided plug does not fit into your outlet, consult an electrician for replacement of the obsolete outlet.
  - 10) Protect the power cord from being walked on or pinched particularly at plugs, convenience receptacles, and the point where they exit from the apparatus.
  - 11) Only use attachments/accessories specified by the manufacturer.
  - 12) Use only with the cart, stand, tripod, bracket, or table specified by the manufacturer, or sold with the apparatus. When a cart is used, use caution when moving the cart/apparatus combination to avoid injury from tip-over.
- 
- 13) Unplug this apparatus during lightning storms or when unused for long periods of time.
  - 14) Refer all servicing to qualified service personnel. Servicing is required when the apparatus has been damaged in any way, such as power-supply cord or plug is damaged, liquid has been spilled or objects have fallen into the apparatus, the apparatus has been exposed to rain or moisture, does not operate normally, or has been dropped.

## Owner's Record

The model and serial numbers are located at the rear of the unit. Record the serial number in the space provided below. Refer to them whenever you call upon your Sony dealer regarding this product.

Model No. \_\_\_\_\_

Serial No. \_\_\_\_\_

## For customers in the USA

If this product is not working properly, please call 1-866-909-7669.

## For Customers in Canada

If this product is not working properly, please contact our **Customer Information Service Center** at 1-877-899-7669 or write to us at: Customer Information Service 115 Gordon Baker Road, Toronto, Ontario, M2H 3R6

---

## Precautions

This equipment has been tested and found to comply with the limits set out in the EMC Directive using a connection cable shorter than 3 metres.

## On placement

- Place the player in a location with adequate ventilation to prevent heat build-up in the player.
- Do not place the player on a soft surface such as a rug that might block the ventilation holes.
- Do not install this player in a confined space, such as a bookshelf or similar unit.
- Do not place the player in a location near heat sources, or in a place subject to direct sunlight, excessive dust, or mechanical shock.
- Do not place the player outdoors, in vehicles, on ships, or on other vessels.
- If the player is brought directly from a cold to a warm location, or is placed in a very damp room, moisture may condense on the lenses inside the player. Should this occur, the player may not operate properly. In this case, remove the disc and leave the player turned on for about half an hour until the moisture evaporates.
- Do not install the player in an inclined position. It is designed to be operated in a horizontal position only.
- Do not place metal objects in front of the front panel. It may limit reception of radio waves.
- Do not place the player in a place where medical equipment is in use. It may cause a malfunction of medical instruments.
- If you use a pacemaker or other medical device, consult your physician or the manufacturer of your medical device before using the wireless LAN function.

- Do not place heavy or unstable objects on the player.
- Do not place any objects other than discs on the disc tray. Doing so may cause damage to the player or the object.
- Take out any discs when you move the player. If you don't, the disc may be damaged.
- Disconnect the AC power cord and all other cables from the player when you move the player.

### On power sources

- The player is not disconnected from the AC power source as long as it is connected to the wall outlet, even if the player itself has been turned off.
- Disconnect the player from the wall outlet if you are not going to use the player for a long time. To disconnect the AC power cord, grasp the plug itself; never pull the cord.
- Observe following points to prevent the AC power cord being damaged. Do not use the AC power cord if it is damaged, as doing so may result in an electric shock or fire.
  - Do not pinch the AC power cord between the player and wall, shelf, etc.
  - Do not put anything heavy on the AC power cord or pull on the AC power cord itself.

### On adjusting volume

Do not turn up the volume while listening to a section with very low level inputs or no audio signals. If you do, your ears and the speakers may be damaged when a peak level section is played.

### On cleaning

Clean the cabinet, panel, and controls with a soft cloth. Do not use any type of abrasive pad, scouring powder or solvent such as alcohol or benzene.

### On cleaning discs, disc/lens cleaners

Do not use cleaning discs or disc/lens cleaners (including wet or spray types). These may cause the apparatus to malfunction.

### On replacement of parts

In the events that this player is repaired, repaired parts may be collected for reuse or recycling purposes.

### On connecting to the HDMI OUT jack

Observe the following as improper handling may damage the HDMI OUT jack and the connector.

- Carefully align the HDMI OUT jack on the rear of the player and the HDMI connector by checking their shapes. Make sure the connector is not upside down or tilted.

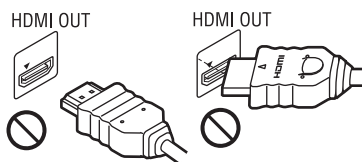

- Be sure to disconnect the HDMI cable when moving the player.



- Hold the HDMI connector straight when connecting or disconnecting the HDMI cable. Do not twist or force the HDMI connector into the HDMI OUT jack.

### On watching 3D video images

Some people may experience discomfort (such as eye strain, fatigue, or nausea) while watching 3D video images. Sony recommends that all viewers take regular breaks while watching 3D video images. The length and frequency of necessary breaks will vary from person to person. You must decide what works best. If you experience any discomfort, you should stop watching the 3D video images until the discomfort ends; consult a doctor if you believe necessary. You should also review (i) the instruction manual and/or the caution message of any other device used with, or Blu-ray Disc contents played with this product and (ii) our website (<http://esupport.sony.com/>) for the latest information. The vision of young children (especially those under six years old) is still under development. Consult your doctor (such as a pediatrician or eye doctor) before allowing young children to watch 3D video images. Adults should supervise young children to ensure they follow the recommendations listed above.

→ continued to page 6

# Table of Contents

WARNING .....	2
Precautions .....	3
Guide to Parts and Controls .....	7

---

## Hookups and Settings

Step 1: Connecting the Player .....	10
Step 2: Easy Setup .....	12
Connecting to the Network .....	12

---

## Playback

Playing a Disc .....	14
Playing from a USB Device .....	15
Playing via a Network .....	15
Available Options .....	17

---

## Internet

Browsing Websites .....	19
-------------------------	----

---

## Settings and Adjustments

Using the Settings Displays .....	21
[Network Update] .....	21
[Screen Settings] .....	21
[Audio Settings] .....	22
[BD/DVD Viewing Settings] .....	23
[Parental Control Settings] .....	23
[Music Settings] .....	24
[System Settings] .....	24
[Network Settings] .....	25
[Easy Setup] .....	25
[Resetting] .....	25

---

## Additional Information

Troubleshooting .....	26
Specifications .....	29
Index .....	33

## IMPORTANT NOTICE

Caution: This player is capable of holding a still video image or on-screen display image on your television screen indefinitely. If you leave the still video image or on-screen display image displayed on your TV for an extended period of time you risk permanent damage to your television screen. Plasma display panel televisions and projection televisions are susceptible to this.

If you have any questions or problems concerning your player, please consult your nearest Sony dealer.

## Copy Protection

Please be advised of the advanced content protection systems used in both Blu-ray Disc™ and DVD media. These systems, called AAC (Advanced Access Content System) and CSS (Content Scramble System), may contain some restrictions on playback, analog output, and other similar features. The operation of this product and the restrictions placed may vary depending on the date of purchase, as the governing board of the AAC may adopt or change its restriction rules after the time of purchase.

## Copyrights and Trademarks

- “AVCHD” and the “AVCHD” logo are trademarks of Panasonic Corporation and Sony Corporation.
- Java, the coffee cup logo, and all Java based marks are trademarks or registered trademarks of Sun Microsystems, Inc. in the U.S. or other countries.
- “XMB,” “XMB,” and “xross media bar” are trademarks of Sony Corporation and Sony Computer Entertainment Inc.
- This product incorporates High-Definition Multimedia Interface (HDMI™) technology. HDMI, the HDMI logo and High-Definition Multimedia Interface are trademarks or registered trademarks of HDMI Licensing LLC in the United States and other countries.
- “Blu-ray Disc” is a trademark.
- “Blu-ray Disc,” “DVD+RW,” “DVD-RW,” “DVD+R,” “DVD-R,” “DVD VIDEO,” and “CD” logos are trademarks.
- “BD-LIVE,” “BD-LIVE” logo, and “BONUSVIEW” are trademarks of Blu-ray Disc Association.
- “Blu-ray 3D” and “Blu-ray 3D” logo are trademarks of Blu-ray Disc Association.
- “x.v.Color” and “x.v.Color” logo are trademarks of Sony Corporation.
- “BRAVIA” is a trademark of Sony Corporation.
- “PhotoTV HD” and the “PhotoTV HD” logo are trademarks of Sony Corporation.
- MPEG Layer-3 audio coding technology and patents licensed from Fraunhofer IIS and Thomson.
- Windows Media is either a registered trademark or trademark of Microsoft Corporation in the

United States and/or other countries.

This product contains technology subject to certain intellectual property rights of Microsoft. Use or distribution of this technology outside of this product is prohibited without the appropriate license(s) from Microsoft.

Content owners use Microsoft PlayReady™ content access technology to protect their intellectual property, including copyrighted content. This device uses PlayReady technology to access PlayReady-protected content and/or WMDRM-protected content. If the device fails to properly enforce restrictions on content usage, content owners may require Microsoft to revoke the device’s ability to consume PlayReady-protected content. Revocation should not affect unprotected content or content protected by other content access technologies. Content owners may require you to upgrade PlayReady to access their content. If you decline an upgrade, you will not be able to access content that requires the upgrade.

- This product meets ENERGY STAR® guidelines for energy efficiency.

ENERGY STAR and the ENERGY STAR mark are registered U.S. marks. ENERGY STAR is a registered mark owned by the U.S. government.

- Music and video recognition technology and related data are provided by Gracenote®. Gracenote is the industry standard in music recognition technology and related content delivery. For more information, please visit [www.gracenote.com](http://www.gracenote.com). CD, DVD, Blu-ray Disc, and music and video-related data from Gracenote, Inc., copyright © 2000-present Gracenote. Gracenote Software, copyright © 2000-present Gracenote. One or more patents owned by Gracenote apply to this product and service. See the Gracenote website for a nonexhaustive list of applicable Gracenote patents. Gracenote, CDDB, MusicID, MediaVOCS, the Gracenote logo and logotype, and the “Powered by Gracenote” logo are either registered trademarks or trademarks of Gracenote in the United States and/or other countries.



- The Wi-Fi CERTIFIED™ Logo is a certification mark of the Wi-Fi Alliance.
- The Wi-Fi Protected Setup™ Mark is a mark of the Wi-Fi Alliance.
- “Wi-Fi CERTIFIED™” and “Wi-Fi Protected Setup™” are trademarks of the Wi-Fi Alliance.
- DLNA®, the DLNA Logo and DLNA CERTIFIED™ are trademarks, service marks, or certification marks of the Digital Living Network Alliance.
- All other trademarks are trademarks of their respective owners.
- Other system and product names are generally trademarks or registered trademarks of the manufacturers.™ and ® marks are not indicated in this document.

# Guide to Parts and Controls

## Front panel

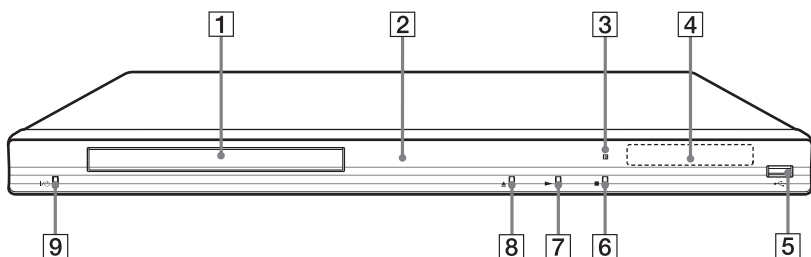

The ► button has a tactile dot. Use the tactile dot as a reference when operating the player.

**1 Disc tray**

**2 Power indicator**

Lights up in white when the player is turned on.

**3 Remote sensor**

**4 Front panel display**

►, ||: Lights up during playback or pause.

↺: Lights up when enabling the repeat setting.

HD: Lights up when outputting 720p/1080i/1080p video signals.

**5 USB jack**

Connect a USB device to this jack.

**6 ■ (stop)**

**7 ► (play)**

**8 ▲ (open/close)**

**9 I/⏻ (on/standby)**

Turns on the player, or sets to standby mode.

### To lock the disc tray (Child Lock)

You can lock the disc tray to prevent it being opened by mistake.

When the player is turned on, hold down ► on the player for more than 10 seconds. The disc tray is locked or unlocked.

## Rear panel

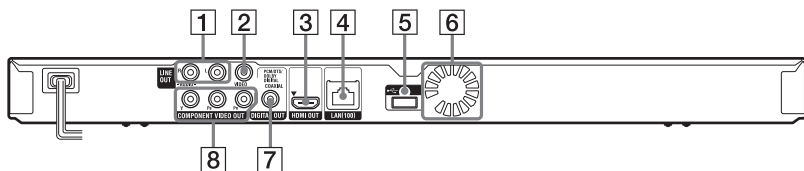

**1 LINE OUT (R-AUDIO-L) jacks**

**2 LINE OUT (VIDEO) jack**

**3 HDMI OUT jack**

**4 LAN (100) terminal**

**5 USB jack**

**6 Ventilation holes**

**7 DIGITAL OUT (COAXIAL) jack**

**8 COMPONENT VIDEO OUT (Y, PB, PR) jacks**

## Remote

The available functions of the remote differ depending on the disc or the situation.

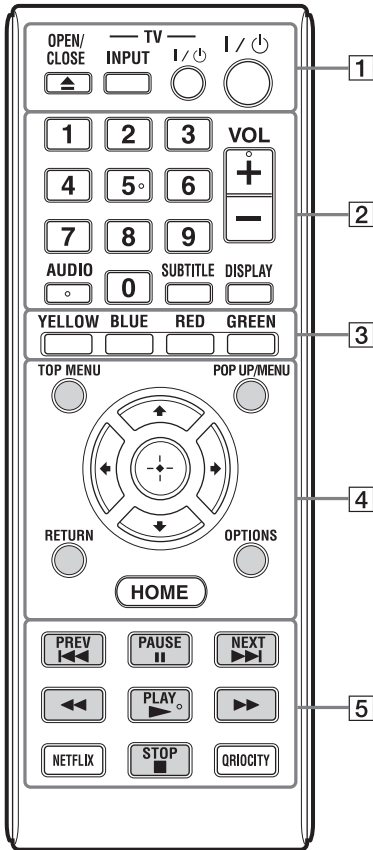

- Number 5, AUDIO, VOL +, and ► PLAY buttons have a tactile dot. Use the tactile dot as a reference when operating the player.
- Gray-colored buttons glow in the dark (BDP-BX58 only).

### The player automatically returns to standby mode

If any button on the player or remote is not pressed for more than 30 minutes, the player automatically returns to standby mode.

#### 1 ▲ OPEN/CLOSE

Opens or closes the disc tray.

#### -TV- INPUT

Switches between TV and other input sources.

#### -TV- I/O (on/standby)

Turns on the TV, or sets to standby mode.

#### I/O (on/standby)

Turns on the player, or sets to standby mode.

#### 2 Number buttons (0 - 9)

Enters the title/chapter numbers, etc.

#### VOL +/-

Adjusts the TV volume.

#### AUDIO (page 23)

Selects the language track when multi-lingual tracks are recorded on BD-ROMs/DVD VIDEOS.

Selects the sound track on CDs.

#### SUBTITLE (page 23)

Selects the subtitle language when multi-lingual subtitles are recorded on BD-ROMs/DVD VIDEOS.

#### DISPLAY (page 14)

Displays the playback and web browsing information on the screen.

#### 3 Color buttons (YELLOW/BLUE/RED/GREEN)

Shortcut keys for interactive functions.

#### 4 TOP MENU

Opens or closes the BD's or DVD's Top Menu.

#### POP UP/MENU

Opens or closes the BD-ROM's Pop-up Menu, or the DVD's menu.

#### OPTIONS (page 17)

The options menu that can be selected appears on the screen.

#### HOME

Enters the player's home menu.

Displays the wall paper when pressed on the category icon of the home menu.

#### RETURN

Returns to the previous display.



Moves the highlight to select a displayed item.



## Center button (ENTER)

Enters the selected item.

## 5 ◀◀ PREV/NEXT ▶▶

Skips to the previous/next chapter, track, or file.

## II PAUSE

Pauses or re-starts playback.

## ◀◀/▶▶ (fast reverse/fast forward)

- Fast reverses/fast forwards the disc when pressed during playback. Each time you press the button during playback of videos, the search speed changes.
- Plays in slow motion, when pressed for more than one second in pause mode.
- Plays one frame at a time, when pressed briefly in pause mode.



Playback in slow motion or one frame is not available for a Blu-ray 3D Disc.

## ▶ PLAY

Starts or re-starts playback.

## NETFLIX (page 15)

Accesses the “NETFLIX” online service.

## ■ STOP

Stops playback and remembers the stop point (resume point).

The resume point for a title/track is the last point you played or the last photo for a photo folder.

## QRIOCITY

Accesses the “Qriocity” online service.

## Home menu display

The home menu appears when you press HOME. Select a category using ◀/▶. Select an item using ↑/↓, and press ENTER.

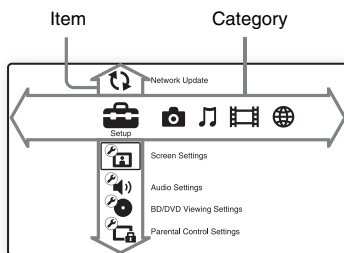

- [Setup]: Adjusts the player settings.
- [Photo]: Displays photos.
- [Music]: Plays music.
- [Video]: Plays videos.
- [Network]: Displays network items.

## Step 1: Connecting the Player

Do not connect the AC power cord until you have made all the connections.  
For supplied accessories, see “Supplied accessories” (page 29).

### Connecting to your TV

Select one of the following connection methods according to the input jacks on your TV. Match the color of the plug to that of the jack when connecting.

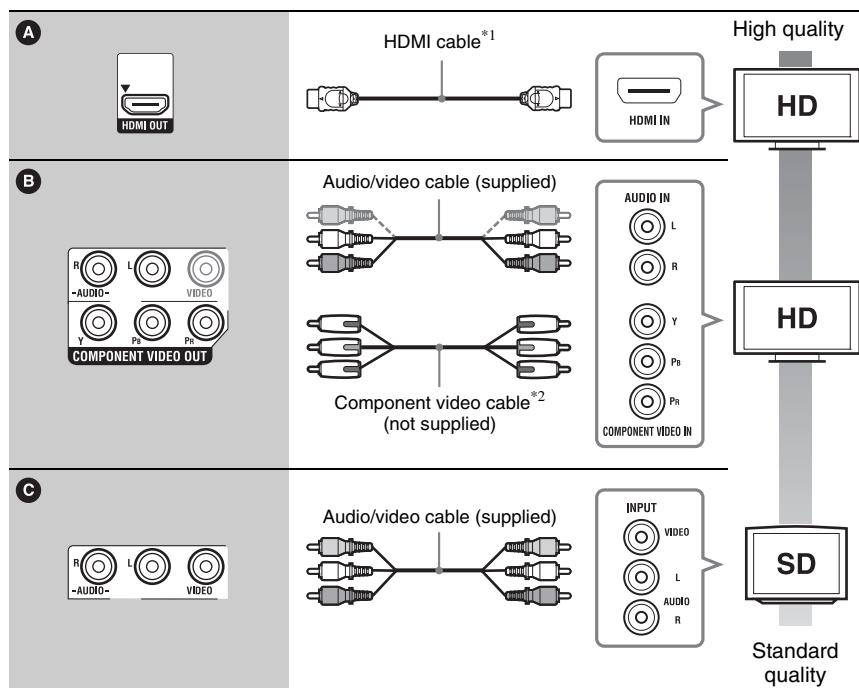
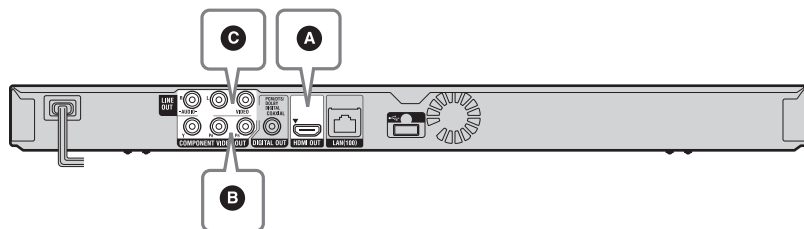

\*<sup>1</sup> See “Supplied accessories” (page 29)

\*<sup>2</sup> Protected content on BD-ROMs is output at 480i resolution from the COMPONENT VIDEO OUT jack (page 6).





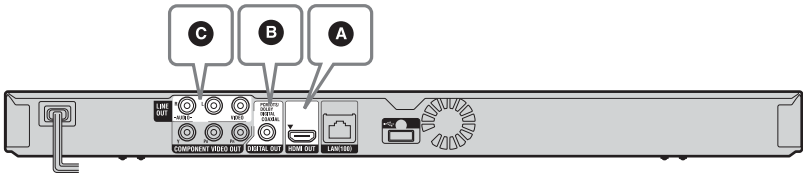

Do not connect the player through a VCR. Video signals fed through VCRs may be affected by copyright protection systems and the picture will be distorted on the television.

## Connecting to your AV amplifier (receiver)

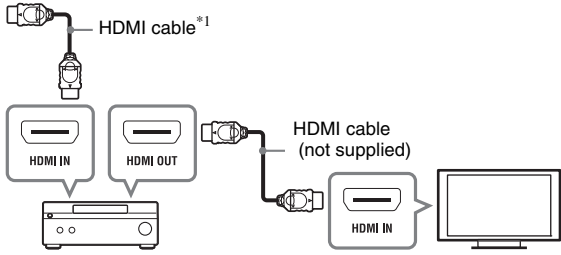
Select one of the following connection methods according to the input jacks on your AV amplifier (receiver). When you select **A** or **B**, make the appropriate settings in the [Audio Settings] setup (page 22).

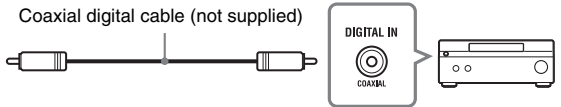

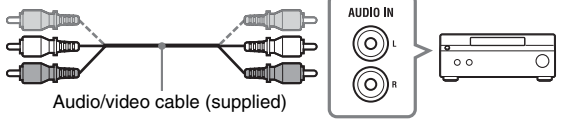
<p><b>A</b></p> 	 <p>HDMI cable*<sup>1</sup></p> <p>HDMI IN    HDMI OUT</p> <p>HDMI IN</p> <p>→ Set [BD Audio MIX Setting] (page 22).</p>
<p><b>B</b></p> 	 <p>Coaxial digital cable (not supplied)</p> <p>DIGITAL IN</p> <p>→ Set [Dolby Digital*<sup>2</sup>] (page 23) and [DTS*<sup>3</sup>] (page 23).</p>
<p><b>C</b></p> 	 <p>Audio/video cable (supplied)</p> <p>AUDIO IN</p>

\*<sup>1</sup> See “Supplied accessories” (page 29).

\*<sup>2</sup> Manufactured under license from Dolby Laboratories.

Dolby, Pro Logic, and the double-D symbol are trademarks of Dolby Laboratories.

\*<sup>3</sup> Manufactured under license under U.S. Patent #'s: 5,451,942; 5,956,674; 5,974,380; 5,978,762; 6,226,616; 6,487,535; 7,212,872; 7,333,929; 7,392,195; 7,272,567 & other U.S. and worldwide patents issued & pending. DTS and the Symbol are registered trademarks, & DTS-HD, DTS-HD Master Audio, and the DTS logos are trademarks of DTS, Inc. Product includes software. © DTS, Inc. All Rights Reserved.

## Step 2: Easy Setup

### When turned on for the first time

Wait for a short while before the player turns on and starts [Easy Setup].

- 1 Insert two Size AA (R6) batteries by matching the  $\oplus$  and  $\ominus$  ends on the batteries to the markings inside the battery compartment.

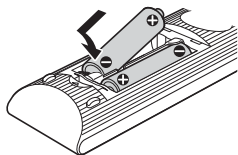

- 2 Plug the player into the AC outlet.



- 3 Press I/⏻ to turn on the player.

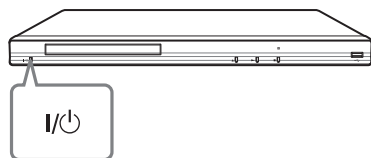

- 4 Turn on the TV, then switch the input selector on your TV so that the signal from the player appears on your TV screen.

- 5 Perform [Easy Setup].

Follow the on-screen instructions to make the basic settings using  $\leftarrow/\uparrow/\downarrow/\rightarrow$  and ENTER on the remote.

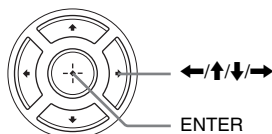

## Connecting to the Network

### Wired Setup

Use a LAN cable to connect to the LAN (100) terminal on the player.

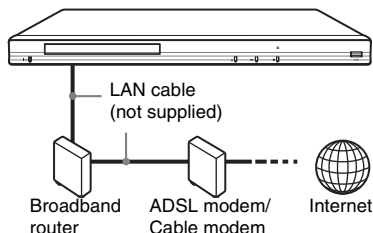

Using a shielded interface cable (LAN cable), straight or crossing, is recommended.

### To set the network settings

Select [Network Settings], [Internet Settings], then [Wired Setup] (page 25), and follow the on-screen instructions to complete the setup.

### USB Wireless Setup

Turn off the player, then connect the USB Wireless LAN Adapter (UWA-BR100 only available as of October 2010) to the USB jack on the front or rear of the player.



The USB Wireless LAN Adapter may not be available in some regions/countries.

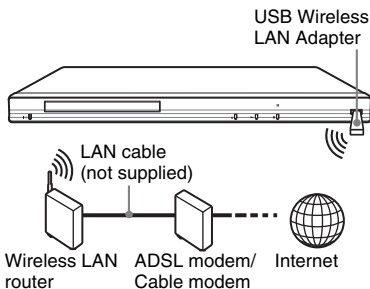

### To set the network settings

Select [Network Settings], [Internet Settings], then [USB Wireless Setup] (page 25), and follow the on-screen instructions to complete the setup.

## Wireless Setup (BDP-S580/ BX58 only)

Use the wireless LAN that is built into the player.

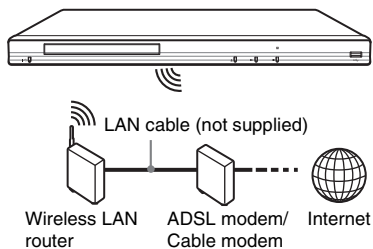

### To set the network settings

Select [Network Settings], [Internet Settings], then [Wireless Setup(built-in)] (page 25), and follow the on-screen instructions to complete the setup.

## Playing a Disc

For playable discs, see “Playable discs” (page 30).

- 1 Switch the input selector on your TV so that the signal from the player appears on your TV screen.
- 2 Press  $\blacktriangle$  OPEN/CLOSE, and place a disc on the disc tray.

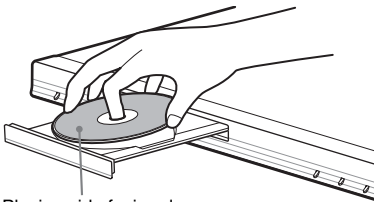

Playing side facing down

- 3 Press  $\blacktriangle$  OPEN/CLOSE to close the disc tray.

Playback starts.

If playback does not start automatically, select  $\bullet$  in the  $\square$  [Video],  $\text{♪}$  [Music], or  $\text{📷}$  [Photo] category, and press ENTER.

## Enjoying BONUSVIEW/BD-LIVE

Some BD-ROMs with the “BD-LIVE” logo\* have bonus content and other data that can be downloaded for enjoyment.

\* BD-LIVE™

- 1 Connect a USB memory to the USB jack on the rear of the player (page 7).  
As your local storage, use a 1 GB or larger USB memory.
- 2 Prepare for BD-LIVE (BD-LIVE only).
  - Connect the player to a network (page 12).
  - Set [BD Internet Connection] to [Allow] (page 23).

## 3 Insert a BD-ROM with BONUSVIEW/BD-LIVE.

The operation method differs depending on the disc. Refer to the instruction manual supplied with the disc.



To delete data in the USB memory, select [Erase BD Data] in the  $\square$  [Video], and press ENTER. All data stored in the buda folder will be erased.

## Enjoying Blu-ray 3D

You can enjoy a Blu-ray 3D Disc with the “Blu-ray 3D” logo\*.



- 1 Prepare for Blu-ray 3D Disc playback.
  - Connect the player to your 3D-compatible devices using a High Speed HDMI cable.
  - Set [3D Output Setting] and [TV Screen Size Setting for 3D] in the [Screen Settings] setup (page 21).
- 2 Insert a Blu-ray 3D Disc.  
The operation method differs depending on the disc. Refer to the instruction manual supplied with the disc.



Refer also to the instruction manuals supplied with your TV and the connected device.

## Displaying the play information

You can check the playback information, etc., by pressing DISPLAY.

The displayed information differs depending on the disc type and player status.

Example: when playing a BD-ROM

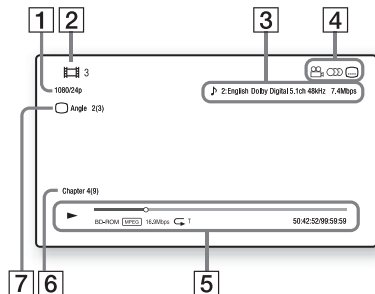

- 1 Output resolution/Video frequency
- 2 Title number or name
- 3 The currently selected audio setting
- 4 Available functions (📐 angle, 🗣️ audio, 📄 subtitle)
- 5 Playback information  
Displays the Play mode, Playing status bar, Disc type, Video codec, Bitrate, Repeat type, Elapsed time, and Total playing time.
- 6 Chapter number
- 7 The currently selected angle

## Playing from a USB Device

You can play video/music/photo files on the connected USB device.  
For playable USB devices, see “Playable types of files” (page 30).

- 1 **Connect the USB device to the USB jack on the player.**  
Refer to the instruction manual supplied with the USB device before connecting.

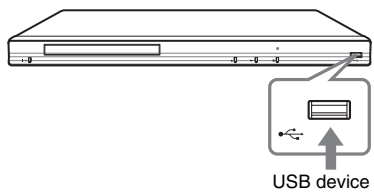

- 2 **Select [Video], [Music], or [Photo] on the home menu using ←/→.**
- 3 **Select [USB device] using ↑/↓, and press ENTER.**

## Playing via a Network

### Streaming BRAVIA Internet Video

Serves as a gateway delivering the selected Internet content and a variety of on-demand entertainment straight to your player.

- 💡 Some Internet content requires registration via a PC before it can be played. For further details, visit the following website:  
<http://www.sony.com/bluraysupport/>
- Some Internet content may not be available in some regions/countries.



- 1 **Prepare for BRAVIA Internet Video.**  
Connect the player to a network (page 12).
- 2 **Select [Video], [Music], or [Photo] on the home menu using ←/→.**
- 3 **Select an Internet content provider icon using ↑/↓, and press ENTER.**  
When an Internet content list has not been acquired, an unacquired icon or a new icon is displayed.

### To use the control panel

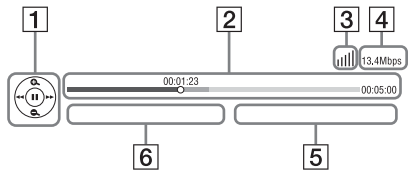
The control panel appears when the video file starts playing. The displayed items may differ depending on Internet content providers.  
To display again, press DISPLAY.



- 1 **Control display**  
Press ←/↑/↓/→ or ENTER for playback operations.
- 2 **Playing status bar**  
Status bar, Cursor indicating the current position, Playing time, Duration of the video file

- 3 Network condition  
 indicates the signal strength for wireless connection.  
 indicates a wired connection.
- 4 Network transmission speed
- 5 The next video file name
- 6 The currently selected video file name

## Playing files on a Home Network (DLNA)

A DLNA-compatible product can play video/music/photo files stored on another DLNA-compatible product via a network.

The following is a list of different kinds of DLNA-compatible products. This unit can be used as Player and Renderer.

- Server: A product that sends data.
- Player: A product that receives and plays data.
- Renderer: A product that receives and plays data.

It can be operated only from other products.



- Controller: A product that controls a renderer.

### 1 Prepare for using DLNA.

- Connect the player to a network (page 12).
- Prepare the other necessary DLNA-compatible products. Refer to the instruction manual supplied with the product.

### To play a file from a DLNA server via this unit (DLNA player)



Select the DLNA server icon from  [Video],  [Music], or  [Photo], then choose the file you want to play.

### To play a file from a DLNA server via another product (Renderer)

When you play files from a DLNA Server on this unit, you can use a DLNA Controller-compatible product (a phone, etc.), to control playback.

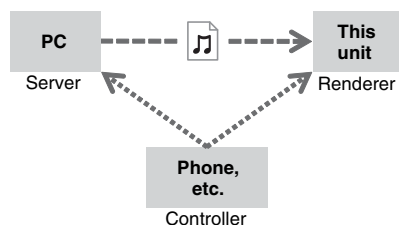

Control this unit using a DLNA controller. Refer to the instruction manual supplied with the DLNA controller.

## Playing the same music in different rooms (PARTY STREAMING)

You can play music in other rooms simultaneously by connecting Sony products which are compatible with DLNA and the PARTY STREAMING function.

The following is a list of different kinds of PARTY STREAMING-compatible products. This unit can be used as a PARTY host and PARTY guest.

- PARTY host: A product that stores and sends music.
- PARTY guest: A product that receives and plays music.

### 1 Prepare for PARTY STREAMING.

- Connect the player to a network (page 12).
- Connect the products which are compatible with the PARTY STREAMING function to a network.



## To use the player as PARTY host

Select a track in  [Music], then select [Start Party] from the options menu to start a PARTY.

To close the PARTY, press HOME.

## To use the player as PARTY guest

Select  [Party] in  [Music], then select the PARTY host product icon.



The sale and product lineup of products that are compatible with the PARTY STREAMING function differ depending on the area.

## Available Options

Various settings and playback operations are available by pressing OPTIONS. The available items differ depending on the situation.

### Common options

Items	Details
[Repeat Setting]	Sets the repeat mode.
[3D Menu]	[3D Depth Adjustment]: Adjusts the depth of 3D image.
[Favorites List]	Displays the Favorites List.
[Play/Stop]	Starts or stops the playback.
[Play from beginning]	Plays the item from the beginning.
[Add to Favorites]	Adds Internet content to the Favorites List.
[Remove from Favorites]	Removes Internet content from the Favorites List.

## [Video] only

Items	Details
[3D Output Setting]	Sets whether or not to output 3D video automatically.
[A/V SYNC]	Adjusts the gap between picture and sound, by delaying the sound output in relation to the picture output (0 to 120 milliseconds).
[Video Settings]	<ul style="list-style-type: none"> <li>• [Picture Quality Mode]: Selects the picture settings for different lighting environments.</li> <li>• [FNR]: Reduces the random noise appearing in the picture.</li> <li>• [BNR]: Reduces the mosaic-like block noise in the picture.</li> <li>• [MNR]: Reduces minor noise around the picture outlines (mosquito noise).</li> </ul>
[Pause]	Pauses the playback.
[Top Menu]	Displays the BD's or DVD's Top Menu.
[Menu/Pop-up Menu]	Displays the BD-ROM's Pop-up Menu or DVD's menu.
[Title Search]	Searches for a title on BD-ROMs/DVD VIDEOS and starts playback from the beginning.
[Chapter Search]	Searches for a chapter and starts playback from the beginning.
[Angle]	Switches to other viewing angles when multi-angles are recorded on BD-ROMs/DVD VIDEOS.
[IP Content Noise Reduction]	Adjusts the picture quality of Internet content.
[Video Search]	Displays information on the BD-ROM/DVD-ROM based on Gracenote technology. Searches for related information using keywords from Gracenote when selecting [Video] or [Cast]. Displays a list of titles when selecting [Playback History] or [Search History].

## [Music] only



Items	Details
[Add Slideshow BGM]	Registers music files in the USB memory as slideshow background music (BGM).
[Start Party]	Starts a PARTY with the selected source. This item may not appear depending on the source.
[Leave Party]	Leaves from a PARTY which the player is participating in. The PARTY STREAMING function continues among other participating products.
[Close Party]	Closes a PARTY which the player is participating in. The PARTY STREAMING function ends for all other participating products.
[Music Search]	Displays information on the audio CD (CD-DA) based on Gracenote technology. Searches for related information using keywords from Gracenote when selecting [Album], [Track] or [Artist]. Displays a list of titles when selecting [Playback History] or [Search History].

## [Photo] only

Items	Details
[Slideshow Speed]	Changes the slideshow speed.
[Slideshow Effect]	Sets the effect for slideshows.
[Slideshow BGM]	<ul style="list-style-type: none"><li>• [Off]: Turns off the function.</li><li>• [My Music from USB]: Sets the music files registered in [Add Slideshow BGM].</li><li>• [Play from Music CD]: Sets the tracks in CD-DAs.</li></ul>
[Slideshow]	Plays a slideshow.
[Rotate Left]	Rotates the photo counterclockwise by 90 degrees.
[Rotate Right]	Rotates the photo clockwise by 90 degrees.

## Browsing Websites

You can connect to the Internet and enjoy websites.

- 1 Prepare for Internet Browser.**  
Connect the player to a network (page 12).
- 2 Select  [Network] on the home menu using  $\leftarrow/\rightarrow$ .**
- 3 Select  [Internet Browser] using  $\uparrow/\downarrow$ , and press ENTER.**



Some websites use functions which this browser does not support. Some websites may not be displayed correctly, or may not function.

### To enter a URL

Select [URL entry] from the options menu. Enter the URL using the software keyboard, then select [Enter].

### To set the default start page

While displaying the page you want to set, select [Set as start page] from the options menu.

### To return to the previous page

Select [Previous page] from the options menu.

When the previous page does not appear even if you select [Previous page], select [Window List] from the options menu and select the page you want to return to from the list.

### To quit Internet Browser

Press HOME.

## Internet Browser display

You can check the website information by pressing DISPLAY. The display information differs depending on the website and page status.

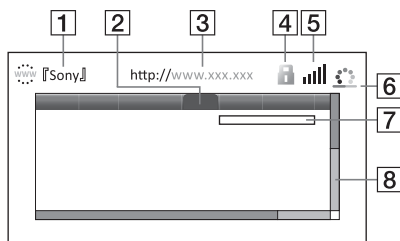

- 1 Page title**
- 2 Cursor**  
Move by pressing  $\leftarrow/\uparrow/\downarrow/\rightarrow$ . Place the cursor on the link you want to view, then press ENTER. The linked website is displayed.
- 3 Page address**
- 4 SSL icon**  
Displays when the website is protected and connected safely.
- 5 Signal strength indicator**  
Appears when the player is connected to a wireless network.
- 6 Progress bar/Loading icon**  
Appears when the page is being read, or during file download/transfer.
- 7 Text input field**  
Press ENTER then choose [Input] from the options menu to open the software keyboard.
- 8 Scroll bar**  
Press  $\leftarrow/\uparrow/\downarrow/\rightarrow$  to move the page display left, up, down or right.

## Available options

Various settings and operations are available by pressing **OPTIONS**.



The available items differ depending on the situation.









Items	Details
[Browser Setup]	Displays the Internet Browser settings. <ul style="list-style-type: none"><li>• [Zoom]: Increases or decreases the size of the displayed contents.</li><li>• [JavaScript Setup]: Enables or disables JavaScript.</li><li>• [Cookie Setup]: Sets whether or not to accept cookies.</li><li>• [SSL Alarm Display]: Enables or disables SSL.</li></ul>
[Input]	Displays the software keyboard to enter characters while browsing a website.
[Break]	Moves the cursor to the next line in the text input field.
[Delete]	Erases one character on the left side of the cursor during text input.
[Window List]	Displays a list of currently opened website windows. Allows you to return to a previously displayed website by selecting the window.
[Bookmark List]	Displays the bookmark list.
[Character encoding]	Sets the character code.
[Previous page/Next page]	Moves to the previous/next page.
[Cancel loading]	Stops loading a page.
[Reload]	Reloads the same page.
[URL entry]	Allows you to enter a URL when the software keyboard is displayed.
[Add to Bookmark]	Adds the currently displayed website to the bookmark list.
[Set as start page]	Sets the currently displayed website as the default start page.
[Open in new window]	Opens a link in a new window.



Items	Details
[Display certificate]	View server certificates sent from pages that support SSL.

## Using the Settings Displays

Select  [Setup] on the home menu when you need to change the settings of the player. The default settings are underlined.

- 1 Select  [Setup] on the home menu using .
- 2 Select the setup category icon using , and press ENTER.

Icon	Explanation
	<b>[Network Update] (page 21)</b> Updates the software of the player.
	<b>[Screen Settings] (page 21)</b> Makes the video settings according to the type of connecting jacks.
	<b>[Audio Settings] (page 22)</b> Makes the audio settings according to the type of connecting jacks.
	<b>[BD/DVD Viewing Settings] (page 23)</b> Makes detailed settings for BD/DVD playback.
	<b>[Parental Control Settings] (page 23)</b> Makes detailed settings for the Parental Control function.
	<b>[Music Settings] (page 24)</b> Makes detailed settings for Super Audio CD playback.
	<b>[System Settings] (page 24)</b> Makes the player-related settings.
	<b>[Network Settings] (page 25)</b> Makes detailed settings for the Internet and network.

Icon	Explanation
 1•2•3	<b>[Easy Setup] (page 25)</b> Re-runs the Easy Setup to make the basic settings.
	<b>[Resetting] (page 25)</b> Resets the player to the factory settings.

## [Network Update]

Select [OK] to update the player's software via the network.



- We recommend the network update every 2 months or so.
- For information about update functions, visit the following website:  
<http://www.sony.com/bluraysupport/>

## [Screen Settings]

### ■ [3D Output Setting]

[Auto]: Normally select this.

[Off]: Select this to display all content in 2D.

### ■ [TV Screen Size Setting for 3D]

Sets the screen size of your 3D-compatible TV.

### ■ [TV Type]

[16:9]: Select this when connecting to a wide-screen TV or a TV with a wide mode function.

[4:3]: Select this when connecting to a 4:3 screen TV without a wide mode function.

### ■ [Screen Format]

[Original]: Select this when connecting to a TV with a wide mode function. Displays a 4:3 screen picture in 16:9 aspect ratio even on a wide-screen TV.

[Fixed Aspect Ratio]: Changes the picture size to fit the screen size with the original picture aspect ratio.

---

### ■ [DVD Aspect Ratio]

[Letter Box]: Displays a wide picture with black bands on the top and bottom.



[Pan & Scan]: Displays a full-height picture on the entire screen, with trimmed sides.



---

### ■ [Cinema Conversion Mode]

[Auto]: Normally select this. The player automatically detects whether the material is video-based or film-based, and switches to the appropriate conversion method.

[Video]: The conversion method suited for video-based material will always be selected regardless of the material.

---

### ■ [Output Video Format]

[HDMI]: Normally select [Auto].

Select [Original Resolution] to output the resolution recorded on the disc. When the resolution is lower than the SD resolution, it is scaled up to the SD resolution.

[Component Video]: Select the resolution that suits your TV.

[Video]: Automatically sets the lowest resolution.



- When connecting the HDMI OUT jack and other video output jacks at the same time, select [Component Video].
- If no picture appears when setting [HDMI] or [Component Video] resolution, try another resolution setting.
- When connecting via the COMPONENT VIDEO OUT jack and [Component Video] is selected, BD-ROM playback of protected content is only supported at 480i output resolution (page 6).

---

### ■ [BD/DVD-ROM 1080/24p Output]

[Auto]: Outputs 1920 × 1080p/24 Hz video signals only when connecting a 1080/24p-compatible TV using the HDMI OUT jack.

[Off]: Select this when your TV is not compatible with 1080/24p video signals.

---

### ■ [YCbCr/RGB (HDMI)]

[Auto]: Automatically detects the connected TV type, and switches to the matching color setting.

[YCbCr (4:2:2)]: Outputs YCbCr 4:2:2 video signals.

[YCbCr (4:4:4)]: Outputs YCbCr 4:4:4 video signals.

[RGB]: Outputs RGB video signals.

---

### ■ [HDMI Deep Color Output]

[Auto]: Normally select this.

[16bit], [12bit], [10bit]: Outputs 16bit/12bit/10bit video signals when the connected TV is compatible with Deep Color.

[Off]: Select this when the picture is unstable or colors appear unnatural.

---

### ■ [Pause Mode]

[Auto]: Normally select this. Dynamic moving pictures appear without blurring.

[Frame]: Displays static pictures at high resolution.



## ■ [Audio Settings]

---

### ■ [Audio (HDMI)]

[Auto]: Normally select this. Outputs audio signals according to the status of the connected HDMI device.

[PCM]: Outputs PCM signals from the HDMI OUT jack.

---

### ■ [DSD Output Mode]

[On]: Outputs DSD signals from the HDMI OUT jack when playing a Super Audio CD. When [On] is selected, no signal is output from other jacks.

[Off]: Outputs PCM signals from the HDMI OUT jack when playing a Super Audio CD.

---

### ■ [BD Audio MIX Setting]

[On]: Outputs the audio obtained by mixing the interactive and secondary audio to the primary audio.

[Off]: Outputs the primary audio only. Select this to output HD audio signals to an AV amplifier (receiver).

**■ [Dolby Digital]**

[Downmix PCM]: Converts to output Linear PCM signals. Select this when connecting an audio device without a built-in Dolby Digital decoder.

[Dolby Digital]: Select this when connecting an audio device with a built-in Dolby Digital decoder.

**■ [DTS]**

[Downmix PCM]: Converts to output Linear PCM signals. Select this when connecting to an audio device without a built-in DTS decoder.

[DTS]: Select this when connecting to an audio device with a built-in DTS decoder.

**■ [DTS Neo:6]**

[Cinema]: Outputs simulated multichannel sound from 2 channel sources via the HDMI OUT jack according to the capability of the connected device using DTS Neo:6 Cinema mode.

[Music]: Outputs simulated multichannel sound from 2 channel sources via the HDMI OUT jack according to the capability of the connected device using DTS Neo:6 Music mode.

[Off]: Outputs sound with its original number of channels via the HDMI OUT jack.

**■ [Audio DRC]**

[Auto]: Performs playback at the dynamic range specified by the disc (BD-ROM only). Other discs are played back at the [On] level.

[On]: Performs playback at a standard compression level.

[Off]: No compression works. A more dynamic sound is produced.

**■ [Downmix]**

[Surround]: Outputs audio signals with surround effects. Select this when connecting an audio device that supports Dolby Surround (Pro Logic) or DTS Neo:6.

[Stereo]: Outputs audio signals without surround effects. Select this when connecting an audio device that does not support Dolby Surround (Pro Logic) or DTS Neo:6.



## [BD/DVD Viewing Settings]

**■ [BD/DVD Menu]**

Selects the default menu language for BD-ROMs or DVD VIDEOS.

When you select [Select Language Code], the display for entering the language code appears. Enter the code for your language by referring to “Language code list” (page 32).

**■ [Audio]**

Selects the default track language for BD-ROMs or DVD VIDEOS.

When you select [Original], the language given priority in the disc is selected.

When you select [Select Language Code], the display for entering the language code appears. Enter the code for your language by referring to “Language code list” (page 32).

**■ [Subtitle]**

Selects the default subtitle language for BD-ROMs or DVD VIDEOS.

When you select [Select Language Code], the display for entering the language code appears. Enter the code for your language by referring to “Language code list” (page 32).

**■ [BD Hybrid Disc Playback Layer]**

[BD]: Plays BD layer.

[DVD/CD]: Plays DVD or CD layer.

**■ [BD Internet Connection]**

[Allow]: Normally select this.

[Do not allow]: Prohibits Internet connection.



## [Parental Control Settings]

**■ [Password]**

Sets or changes the password for the Parental Control function. A password allows you to set a restriction on BD-ROM or DVD VIDEO, and Internet video playback. If necessary, you can differentiate the restriction levels for BD-ROMs, DVD VIDEOS, and Internet videos.

---

### ■ [Parental Control Area Code]

Playback of some BD-ROMs, DVD VIDEOS, or Internet videos can be limited according to the geographic area. Scenes may be blocked or replaced with different scenes. Follow the on-screen instructions and enter your four-digit password.

---

### ■ [BD Parental Control]

Playback of some BD-ROMs can be limited according to the age of the users. Scenes may be blocked or replaced with different scenes. Follow the on-screen instructions and enter your four-digit password.

---

### ■ [DVD Parental Control]

Playback of some DVD VIDEOS can be limited according to the age of the users. Scenes may be blocked or replaced with different scenes. Follow the on-screen instructions and enter your four-digit password.

---

### ■ [Internet Video Parental Control]

Playback of some Internet videos can be limited according to the age of the users. Scenes may be blocked or replaced with different scenes. Follow the on-screen instructions and enter your four-digit password.

---

### ■ [Internet Video Unrated]

[Allow]: Allows the playback of unrated Internet videos.

[Block]: Blocks the playback of unrated Internet videos.

---



## [Music Settings]

---

### ■ [Super Audio CD Playback Layer]

[Super Audio CD]: Plays the Super Audio CD layer.

[CD]: Plays the CD layer.

---

### ■ [Super Audio CD Playback Channel]

[DSD 2ch]: Plays the 2ch area.

[DSD Multi]: Plays the multi-channel area.

---



## [System Settings]

---

### ■ [OSD]

Selects your language for the player on-screen displays.

---

### ■ [Dimmer]

[Bright]: Bright lighting.

[Dark]: Low lighting.

[Off]: Turns off the lighting during playback. Low lighting other than during playback.

---

### ■ [Control for HDMI]

[On]: The following BRAVIA Sync features are available:

–One-Touch Play

–System Power-Off

–Language Follow

[Off]: Turns off the function.

---



For details, refer to the instruction manual supplied with the TV or components.

---

### ■ [HDMI: Linked to TV-off]

[On]: Automatically turns off the player and HDMI-compatible components when the connected TV enters standby mode (BRAVIA Sync).

[Off]: Turns off the function.

---

### ■ [Quick Start Mode]

[On]: Shortens the startup time when turning on the player.

[Off]: Reduces standby power consumption.

---

### ■ [Auto Display]

[On]: Automatically displays information on the screen when changing the viewing titles, picture modes, audio signals, etc.

[Off]: Displays information only when you press DISPLAY.

---

### ■ [Screen Saver]

[On]: Turns on the screen saver function.

The screen saver image appears when you do not use the player for more than 10 minutes while an on-screen display is displayed.

[Off]: Turns off the function.

---

### ■ [Software Update Notification]

[On]: Sets the player to inform you of newer software version information (page 21).

[Off]: Turns off the function.

---



---

**■ [Gracenote Settings]**

[Auto]: Automatically downloads disc information when disc playback stops. Connect to the network for downloading.  
 [Manual]: Downloads the disc information when [Video Search] or [Music Search] is selected.

---

**■ [System Information]**

Displays the player's software version information and the MAC address.

---

 **[Network Settings]**

---

**■ [Internet Settings]**

Connect the player to the network beforehand. For details, see "Connecting to the Network" (page 12).

[View Network Status]: Displays the current network status.

[Wired Setup]: Select this when you connect to a broadband router using a LAN cable.

[Wireless Setup(built-in)] (BDP-S580/BX58 only): Select this when you use the wireless LAN that is built into the player for wireless network connection.

[USB Wireless Setup]: Select this when you use a USB Wireless LAN Adapter for wireless network connection.



For further details, visit the following website and check the FAQ contents:  
<http://www.sony.com/bluraysupport/>

---

**■ [Network Connection Diagnostics]**

You can run the network diagnostic to check if the network connection has been made properly.

---

**■ [Connection Server Settings]**

Sets whether or not to display the connected server.

---

**■ [Renderer Options]**

[Auto Access Permission]: Sets whether or not to allow automatic access from newly detected DLNA renderer-compatible product.

[Renderer Name]: Displays the player's name as it is listed on other DLNA products on the network.

---

**■ [Renderer Access Control]**

Displays a list of DLNA controller-compatible products and sets whether or not each product is accessible via this player.

---

**■ [Party Auto Start]**

[On]: Starts a PARTY or joins an existing PARTY at the request of a networked product compatible with the PARTY STREAMING function.

[Off]: Turns off the function.

---

**■ [Media Remote Device Registration]**

Registers your "Media Remote" device.

---

**■ [Registered Media Remote Devices]**

Displays a list of the registered your "Media Remote" devices.

---

 **[Easy Setup]**

---

Re-runs the [Easy Setup] to make the basic settings. Follow the on-screen instructions.

---

 **[Resetting]**

---

**■ [Reset to Factory Default Settings]**

You can reset the player settings to the factory default by selecting the group of settings. All the settings within the group will be reset.

---

**■ [Initialize Personal Information]**

You can erase your personal information stored in the player.

## Troubleshooting

If you experience any of the following difficulties while using the player, use this troubleshooting guide to help remedy the problem before requesting repairs. Should any problem persist, consult your nearest Sony dealer.

### Picture

#### There is no picture or the picture is not output correctly.

- ➔ Check that all the connecting cables are securely connected (page 10).
- ➔ Switch the input selector on your TV to display the signal from the player.
- ➔ Reset the video output resolution to the lowest resolution by pressing **■** on the player for more than 10 seconds.
- ➔ For HDMI connections, try the following:
  - ① Turn the player off and on again.
  - ② Turn the connected equipment off and on again.
  - ③ Disconnect and then reconnect the HDMI cable.
- ➔ The HDMI OUT jack is connected to a DVI device that does not support copyright protection technology.
- ➔ For HDMI connections, check the [Output Video Format] settings in the [Screen Settings] setup (page 22).
- ➔ When the analog signals are also output, set [BD/DVD-ROM 1080/24p Output] to [Off] in the [Screen Settings] setup (page 22).
- ➔ For BD-ROMs, check the [BD/DVD-ROM 1080/24p Output] setting in the [Screen Settings] setup (page 22).

#### The display language on the screen switches automatically when connected to the HDMI OUT jack.

- ➔ When [Control for HDMI] is set to [On] (page 24), the display language on the screen automatically switches according to the language setting of the connected TV (if you change the setting on your TV, etc.).

### Sound

#### There is no sound or the sound is not output correctly.

- ➔ Check that all the connecting cables are securely connected (page 10).
- ➔ Switch the input selector on your AV amplifier (receiver) so that the audio signals of the player are output from your AV amplifier (receiver).
- ➔ If the audio signal does not come through the DIGITAL OUT (COAXIAL)/HDMI OUT jack, check the audio settings (page 22).
- ➔ For HDMI connections, try the following:
  - ① Turn the player off and on again.
  - ② Turn the connected equipment off and on again.
  - ③ Disconnect and then reconnect the HDMI cable.
- ➔ For HDMI connections, if the player is connected to a TV through an AV amplifier (receiver), try connecting the HDMI cable directly to the TV. Refer also to the instruction manual supplied with the AV amplifier (receiver).
- ➔ The HDMI OUT jack is connected to a DVI device (DVI jacks do not accept audio signals).
- ➔ The device connected to the HDMI OUT jack does not support the audio format of the player. Check the audio settings (page 22).

#### The HD Audio (Dolby Digital Plus, Dolby TrueHD, DTS-HD High Resolution Audio, and DTS-HD Master Audio) is not output by bitstream.

- ➔ Set [BD Audio MIX Setting] to [Off] in the [Audio Settings] setup (page 22).
- ➔ Check that the connected AV amplifier (receiver) is compatible with each HD Audio format.

#### The interactive audio is not output.

- ➔ Set [BD Audio MIX Setting] to [On] in the [Audio Settings] setup (page 22).

### Disc

#### The disc does not play.

- ➔ The disc is dirty or skewed.
- ➔ The disc is upside down. Insert the disc with the playback side facing down.
- ➔ The disc has a format that cannot be played back by this player (page 30).

- ➔ The player cannot play a recorded disc that is not correctly finalized.
- ➔ The region code on the BD or DVD does not match the player.

## USB device

### The player does not detect a USB device connected to the player.

- ➔ Make sure that the USB device is securely connected to the USB jack.
- ➔ Check if the USB device or a cable is damaged.
- ➔ Check if the USB device is on.
- ➔ If the USB device is connected via a USB hub, connect the USB device directly to the player.

## BRAVIA Internet Video

### The picture/sound is poor/certain programs display a loss of detail, especially during fast-motion or dark scenes.

- ➔ Picture/sound quality may be poor depending on Internet content providers.
- ➔ Picture/sound quality may be improved by changing the connection speed. We recommend a connection speed of at least 2.5 Mbps for standard definition video (10 Mbps for high definition video).
- ➔ Not all videos will contain sound.

### The picture is small.

- ➔ Press **↑** to zoom in.

## Network connection

### The player cannot connect to the network.

- ➔ Check the network connection (page 12) and the network settings (page 25).

### You cannot connect your PC to the Internet after [Wi-Fi Protected Setup (WPS)] is performed.

- ➔ The wireless settings of the router may change automatically if you use the Wi-Fi Protected Setup function before adjusting the settings of the router. In this case, change the wireless settings of your PC accordingly.

### You cannot connect the player to the wireless LAN router.

- ➔ Check if the wireless LAN router is on.
- ➔ Depending on the surrounding environment, such as the wall material, radio wave receiving condition, or obstacles between the player and the wireless LAN router, the communication distance may be shortened. Move the player and the wireless LAN router closer to each other.
- ➔ Devices that use a 2.4 GHz frequency band, such as a microwave, Bluetooth, or digital cordless device, may interrupt the communication. Move the player away from such devices, or turn off such devices.

### The desired wireless router is not detected even if [Scan] is performed.

- ➔ Press RETURN to return to the previous screen, and try [Scan] again. If the desired wireless router is still not detected, press RETURN to select [Manual registration].

### The message [A new software version is available. Please go to the "Setup" section of the menu and select "Network update" to perform the update.] appears on the screen when turning the player on.

- ➔ See [Network Update] (page 21) to update the player to a newer software version.

### You cannot start the PARTY STREAMING function.

- ➔ Check that [Party Auto Start] is set to [On] in [Network Settings] (page 25).

## Control for HDMI (BRAVIA Sync)

### The [Control for HDMI] function does not work (BRAVIA Sync).

- ➔ Check that [Control for HDMI] is set to [On] (page 24).
- ➔ If you change the HDMI connection, turn the player off and on again.
- ➔ If power failure occurs, set [Control for HDMI] to [Off], then set [Control for HDMI] to [On] (page 24).
- ➔ Check the following and refer to the instruction manual supplied with the component.
  - the connected component is compatible with the [Control for HDMI] function.
  - the connected component's setting for the [Control for HDMI] function is correct.

- ➔ When you connect the player to a TV through an AV amplifier (receiver),
  - if the AV amplifier (receiver) is not compatible with the [Control for HDMI] function, you may be unable to control the TV from the player.
  - if you change the HDMI connection, disconnect and reconnect the AC power cord, or a power failure occurs, try the following: ①Switch the input selector of the AV amplifier (receiver) so that the picture from the player appears on the TV screen. ②Set [Control for HDMI] to [Off], then set [Control for HDMI] to [On] (page 24). Refer to the instruction manual supplied with the AV amplifier (receiver).

---

### **The System Power-Off function does not work (BRAVIA Sync).**

- ➔ Check that [Control for HDMI] and [HDMI: Linked to TV-off] are set to [On] (page 24).

## **Others**

---

### **Playback does not start from the beginning of content.**

- ➔ Press **OPTIONS**, and select [Play from beginning].

---

### **Playback does not start from the resume point where you last stopped playing.**

- ➔ The resume point may be cleared from memory depending on the disc when
  - you open the disc tray.
  - you disconnect the USB device.
  - you play other content.
  - you turn off the player.

---

### **The disc tray does not open and “LOCKED” or “TLK ON” appears on the front panel display.**

- ➔ When “LOCKED” appears, the player is locked. To cancel the Child Lock, hold down **▶** on the player until “UNLOCK” appears on the front panel display (page 7).
- ➔ When “TLK ON” appears, contact your Sony dealer or local authorized Sony service facility.

---

### **The disc tray does not open and you cannot remove the disc even after you press **▲**.**

- ➔ Try the following: ①Turn the player off, and disconnect the AC power cord. ②Reconnect the AC power cord while pressing down **▲** on the player. ③Keep pressing down **▲** on the player until the tray opens. ④Remove the disc. ⑤When “OPEN” appears on the front panel display, hold down **I/⏻** on the player for more than 10 seconds until the player turns off.

---

### **“Exxxx” or “FAN ERR” appears on the front panel display.**

- ➔ When “Exxxx” appears, contact your nearest Sony dealer or local authorized Sony service facility and give the error code.
- ➔ When “FAN ERR” appears, try the following: ①Check that the ventilation holes on the rear of the player are not blocked. ②Place the player in a location with adequate ventilation to prevent heat build-up in the player.

---

### **The player does not respond to any button.**

- ➔ Moisture has condensed inside the player (page 3).
- ➔ Hold down **I/⏻** on the player for more than 10 seconds until the indicators on the front panel display turn off. If the player still does not respond to any button, disconnect then reconnect the AC power cord.

# Specifications

## System

**Laser:** Semiconductor laser

## Inputs and outputs

(Jack name:

Jack type/Output level/Load impedance)

### LINE OUT R-AUDIO-L:

Phono jack/2 V<sub>rms</sub>/10 kilohms

### DIGITAL OUT (COAXIAL):

Phono jack/0.5 V<sub>p-p</sub>/75 ohms

### HDMI OUT:

HDMI 19-pin standard connector

### COMPONENT VIDEO OUT (Y, P<sub>B</sub>, P<sub>R</sub>):

Phono jack/Y: 1.0 V<sub>p-p</sub>/

P<sub>B</sub>, P<sub>R</sub>: 0.7 V<sub>p-p</sub>/75 ohms

### LINE OUT VIDEO:

Phono jack/1.0 V<sub>p-p</sub>/75 ohms

### LAN (100):

100BASE-TX Terminal

### USB:

USB jack Type A (For connecting a USB memory, memory card reader, digital still camera, and digital video camera)

## Wireless (BDP-S580/BX58 only)

### Wireless LAN standard:

IEEE 802.11 b/g/n

### Frequency range:

2.4 GHz band: Channels 1-11

### Modulation:

DSSS and OFDM

## General

### Power requirements:

120V AC, 60Hz

### Power consumption:

BDP-S480: 20 W

BDP-S580/BX58: 22 W

### Dimensions (approx.):

430 mm × 199 mm × 36 mm

(17 in. × 7 7/8 in. × 1 7/16 in.)

(width/depth/height) incl. projecting parts

### Mass (approx.):

1.7 kg (3 lb 12 oz)

### Operating temperature:

5 °C to 35 °C (41 °F to 95 °F)

### Operating humidity:

25 % to 80 %

## Supplied accessories

- Audio/video cable (phono plug ×3) (1)
- HDMI cable (1) (BDP-BX58 only)
- Remote commander (remote) (1)
- Size AA (R6) batteries (2)

Specifications and design are subject to change without notice.

## Notes About the Discs

- To keep the disc clean, handle the disc by its edge. Do not touch the surface. Dust, fingerprints, or scratches on the disc may cause it to malfunction.



- Do not expose the disc to direct sunlight or heat sources such as hot air ducts, or leave it in a car parked in direct sunlight as the temperature may rise considerably inside the car.
- After playing, store the disc in its case.
- Clean the disc with a cleaning cloth. Wipe the disc from the center out.



- Do not use solvents such as benzene, thinner, commercially available disc/lens cleaners, or anti-static spray intended for vinyl LPs.
- If you have printed the disc's label, dry the label before playing.
- Do not use the following discs.
  - A lens cleaning disc.
  - A disc that has a non-standard shape (e.g., card, heart).
  - A disc with a label or sticker on it.
  - A disc that has cellophane tape or sticker adhesive on it.
- Do not resurface the playing side of a disc to remove surface scratches.

## Playable discs

<b>Blu-ray Disc</b> <sup>*1</sup>	BD-ROM BD-R <sup>*2</sup> /BD-RE <sup>*2</sup>
<b>DVD</b> <sup>*3</sup>	DVD-ROM DVD-R/DVD-RW DVD+R/DVD+RW
<b>CD</b> <sup>*3</sup>	CD-DA (Music CD) CD-ROM CD-R/CD-RW Super Audio CD

<sup>\*1</sup> Since the Blu-ray Disc specifications are new and evolving, some discs may not be playable depending on the disc type and the version. The audio output differs depending on the source, connected output jack, and selected audio settings.

<sup>\*2</sup> BD-RE: Ver.2.1

BD-R: Ver.1.1, 1.2, 1.3 including organic pigment type BD-R (LTH type)

The BD-Rs recorded on a PC cannot be played if postscripts are recordable.

<sup>\*3</sup> A CD or DVD disc will not play if it has not been correctly finalized. For more information, refer to the instruction manual supplied with the recording device.

### Discs that cannot be played

- BDs with cartridge
- BDXLs
- DVD-RAMs
- HD DVDs
- DVD Audio discs
- PHOTO CDs
- Data part of CD-Extras
- Super VCDs
- Audio material side on DualDiscs
- A disc recorded in a color system other than NTSC, such as PAL (this player conforms to the NTSC color system).

### Note on Discs

This product is designed to playback discs that conform to the Compact Disc (CD) standard. DualDiscs and some of the music discs encoded with copyright protection technologies do not conform to the Compact Disc (CD) standard, therefore, these discs may not be playable by this product.

### Note on playback operations of BDs/DVDs

Some playback operations of BDs/DVDs may be intentionally set by software producers. Since this player plays BDs/DVDs according to the disc contents the

software producers designed, some playback features may not be available.

### Note about double-layer BDs/DVDs

The playback pictures and sound may be momentarily interrupted when the layers switch.

### Region code (BD-ROM/DVD VIDEO only)

Your player has a region code printed on the rear of the unit and will only play BD-ROMs/ DVD VIDEOS labeled with identical region codes or .

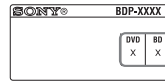

Region code

## Playable types of files

### Video

File format	Extensions
MPEG-1 Video/PS <sup>*1*2</sup> MPEG-2 Video/PS, TS <sup>*1*3</sup>	“.mpg,” “.mpeg,” “.m2ts,” “.mts”
MPEG-4 AVC <sup>*1*2</sup>	“.mkv,” “.mp4,” “.m4v,” “.m2ts,” “.mts”
WMV9 <sup>*1*2</sup>	“.wmv,” “.asf”
AVCHD <sup>*2</sup>	*4
Xvid	“.avi”

### Music

File format	Extensions
MP3 (MPEG-1 Audio Layer III)	“.mp3”
AAC <sup>*1*2*5</sup>	“.m4a”
WMA9 Standard <sup>*1*2*5</sup>	“.wma”
LPCM	“.wav”

### Photo

File format	Extensions
JPEG	“.jpg,” “.jpeg”

<sup>\*1</sup> The player does not play coded files such as DRM.

<sup>\*2</sup> The player does not play this file format on a DLNA server.

<sup>\*3</sup> The player can only play standard definition video on a DLNA server.

\*4 The player plays AVCHD format files that are recorded on a digital video camera, etc. The AVCHD format disc will not play if it has not been correctly finalized.

\*5 The player does not play coded files such as Lossless.



- Some files may not play depending on the file format, file encoding, recording condition, or DLNA server condition.
- Some files edited on a PC may not play.
- The player can recognize the following files or folders in BDs, DVDs, CDs and USB devices:
  - up to folders in the 3rd tree
  - up to 500 files in a single tree
- The player can recognize the following files or folders stored in the DLNA server:
  - up to folders in the 18th tree
  - up to 999 files in a single tree
- Some USB devices may not work with this player.
- The player can recognize Mass Storage Class (MSC) devices (such as flash memory or an HDD), Still Image Capture Device (SICD) class devices and 101 keyboard (front USB jack only).
- To avoid data corruption or damage to the USB memory or devices, turn the player off when connecting or removing the USB memory or devices.
- The player may not play high bit rate video files on DATA CDs smoothly. You are recommended to play such files using DATA DVDs.

## About wireless LAN security

Since communication via the wireless LAN function is established by radio waves, the wireless signal may be susceptible to interception. To protect wireless communication, this player supports various security functions. Be sure to correctly configure the security settings in accordance with your network environment.

### ◆ No Security

Although you can easily make settings, anyone can intercept wireless communication or intrude into your wireless network, even without any sophisticated tools. Keep in mind that there is a risk of unauthorized access or interception of data.

### ◆ WEP

WEP applies security to communications to prevent outsiders from intercepting communications or intruding into your wireless network. WEP is a legacy security technology that enables older devices, which do not support TKIP/AES, to be connected.

### ◆ WPA-PSK (TKIP), WPA2-PSK (TKIP)

TKIP is a security technology developed to correct for the deficiencies of WEP. TKIP assures a higher security level than WEP.

### ◆ WPA-PSK (AES), WPA2-PSK (AES)

AES is a security technology that uses an advanced security method that is distinct from WEP and TKIP.

AES assures a higher security level than WEP or TKIP.

## Code numbers of controllable TVs

While holding down -TV- , enter the TV manufacturer's code using the number buttons.

If more than one code number is listed, try entering them one at a time until you find the one that works with your TV.

Manufacturer	Code number
Sony	01 (default)
Hitachi	02
LG/Goldstar	04
Mitsubishi/MGA	13
NEC	04
Panasonic	19
Philips	21
Pioneer	16
RCA	10
Samsung	20
Sharp	18
Toshiba	07

## Language code list

For details, see [BD/DVD Viewing Settings] (page 23).

The language spellings conform to the ISO 639: 1988 (E/F) standard.

### Code Language

1027	Afar	1261	Japanese
1028	Abkhazian	1269	Yiddish
1032	Afrikaans	1283	Javanese
1039	Amharic	1287	Georgian
1044	Arabic	1297	Kazakh
1045	Assamese	1298	Greenlandic;
1051	Aymara		Kalaallisut
1052	Azerbaijani	1299	Cambodian;
1053	Bashkir		Khmer
1057	Byelorussian	1300	Kannada
1059	Bulgarian	1301	Korean
1060	Bihari	1305	Kashmiri
1061	Bislama	1307	Kurdish
1066	Bengali	1311	Kirghiz
1067	Tibetan	1313	Latin
1070	Breton	1326	Lingala
1079	Catalan	1327	Laotian; Lao
1093	Corsican	1332	Lithuanian
1097	Czech	1334	Latvian
1103	Welsh	1345	Malagasy
1105	Danish	1347	Maori
1109	German	1349	Macedonian
1130	Bhutani;	1350	Malayalam
	Dzongkha	1352	Mongolian
1142	Greek	1353	Moldavian
1144	English	1356	Marathi
1145	Esperanto	1357	Malay
1149	Spanish	1358	Maltese;
1150	Estonian		Maltese
1151	Basque	1363	Burmese
1157	Persian	1365	Nauru
1165	Finnish	1369	Nepali
1166	Fiji	1376	Dutch
1171	Faroese	1379	Norwegian
1174	French	1393	Occitan
1181	Frisian	1403	Oromo
1183	Irish	1408	Oriya
1186	Scots Gaelic	1417	Punjabi;
1194	Galician		Panjabi
1196	Guarani	1428	Polish
1203	Gujarati	1435	Pashto; Pushto
1209	Hausa	1436	Portuguese
1217	Hindi	1463	Quechua
1226	Croatian	1481	Rhaeto-
1229	Hungarian		Romance
1233	Armenian	1482	Kirundi; Rundi
1235	Interlingua	1483	Romanian
1239	Interlingue	1489	Russian
1245	Inupiak	1491	Kinyarwanda
1248	Indonesian	1495	Sanskrit
1253	Icelandic	1498	Sindhi
1254	Italian	1501	Sangho;
1257	Hebrew		Sango

### Code Language

1502	Serbo-	1531	Turkmen
	Croatian	1532	Tagalog
1503	Singhalese;	1534	Setswana;
	Sinhalese		Tswana
1505	Slovak	1535	Tonga; Tonga
1506	Slovenian		islands
1507	Samoan	1538	Turkish
1508	Shona	1539	Tsonga
1509	Somali	1540	Tatar
1511	Albanian	1543	Twì
1512	Serbian	1557	Ukrainian
1513	Siswati; Swati	1564	Urdu
1514	Sesotho;	1572	Uzbek
	Sotho southern	1581	Vietnamese
1515	Sundanese	1587	Volapük
1516	Swedish	1613	Wolof
1517	Swahili	1632	Xhosa
1521	Tamil	1665	Yoruba
1525	Telugu	1684	Chinese
1527	Tajik	1697	Zulu
1528	Thai	1703	Not specified
1529	Tigrinya		

## Parental control/area code

For details, see [Parental Control Area Code] (page 24).

### Code Area

2044, Argentina	2333, Luxembourg	
2047, Australia	2363, Malaysia	
2046, Austria	2362, Mexico	
2057, Belgium	2376, Netherlands	
2070, Brazil	2390, New Zealand	
2090, Chile	2379, Norway	
2092, China	2427, Pakistan	
2093, Colombia	2424, Philippines	
2115, Denmark	2428, Poland	
2165, Finland	2436, Portugal	
2174, France	2489, Russia	
2109, Germany	2501, Singapore	
2200, Greece	2149, Spain	
2219, Hong Kong	2499, Sweden	
2248, India	2086, Switzerland	
2238, Indonesia	2543, Taiwan	
2239, Ireland	2528, Thailand	
2254, Italy	2184, United	
2276, Japan		Kingdom
2304, Korea		



---

# Index

## Numerics

3D 14  
3D Output Setting 21

## A

AUDIO 8  
Audio Settings 22

## B

BD/DVD Viewing  
Settings 23  
BD-LIVE 14  
BD-R 30  
BD-RE 30  
Bitstream 26  
Blu-ray Disc 30  
BONUSVIEW 14  
BRAVIA Internet Video  
15  
BRAVIA Sync 27

## C

Child Lock 7, 28  
Color buttons 8  
Connecting  
AV amplifier  
(Receiver) 11  
Network 12  
TV 10  
Control for HDMI 24, 27

## D

Deep Color 22  
Dimmer 24  
DISPLAY 8  
DLNA 16, 25  
Dolby Digital 23  
DSD Output Mode 22  
DTS 23

## E

Easy Setup 12, 25

## G

Gracenote Settings 25

## H

HDMI 22  
HDMI: Linked to TV-off  
24, 28  
HOME 8  
Home menu 21

## I

Internet Browser 19  
Internet content 15  
IP Content Noise  
Reduction 17

## L

Language Follow 24

## M

MAC address 25  
Music Settings 24

## N

NETFLIX 9  
Network Settings 25  
Network Update 21

## O

One-Touch Play 24  
OPTIONS 8  
OSD 24

## P

Parental Control 23  
Parental Control Settings  
23  
PARTY STREAMING  
16, 17, 25  
Play information 14  
Playable discs 30  
POP UP/MENU 8

## Q

QRIOCIY 9  
Quick Start Mode 24

## R

Region code 30  
Remote 8  
Resetting 25  
Resetting the player 25  
Resume 9, 28

## S

Screen Settings 21  
Setup 21  
Software update 21, 24  
SUBTITLE 8  
System Power-Off 24  
System Settings 24

## T

TOP MENU 8  
Troubleshooting 26  
TV Screen Size Setting for  
3D 21  
TV Type 21

## U

Update 21  
USB 15

## W

WEP 31  
WPA2-PSK (AES) 31  
WPA2-PSK (TKIP) 31  
WPA-PSK (AES) 31  
WPA-PSK (TKIP) 31



